

RF MOSFET Power Transistor, 5W, 28V

2 - 175 MHz

DU2805S

V2.00

Features

- N-Channel Enhancement Mode Device
- DMOS Structure
- Lower Capacitances for Broadband Operation
- High Saturated Output Power
- Lower Noise Figure Than Bipolar Devices

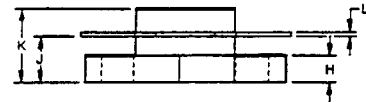
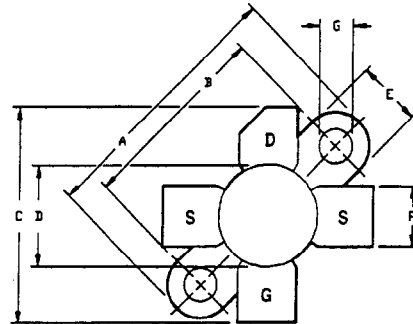

Absolute Maximum Ratings at 25°C

Parameter	Symbol	Rating	Units
Drain-Source Voltage	V_{DS}	65	V
Gate-Source Voltage	V_{GS}	20	V
Drain-Source Current	I_{DS}	1.4	A
Power Dissipation	P_D	15.8	W
Junction Temperature	T_J	200	°C
Storage Temperature	T_{STG}	-55 to +150	°C
Thermal Resistance	θ_{JC}	11.1	°C/W

LETTER DIM	MILLIMETERS		INCHES	
	MIN	MAX	MIN	MAX
A	24.64	24.89	.970	.980
B	18.29	18.54	.720	.730
C	20.07	20.83	.790	.820
D	9.47	9.73	.373	.383
E	6.22	6.48	.245	.255
F	5.64	5.79	.222	.228
G	2.92	3.30	.115	.130
H	2.29	2.67	.090	.105
J	4.04	4.55	.159	.179
K	6.58	7.39	.259	.291
L	.10	.15	.004	.006

Electrical Characteristics at 25°C

Parameter	Symbol	Min	Max	Units	Test Conditions
Drain-Source Breakdown Voltage	BV_{DSS}	65	-	V	$V_{GS}=0.0\text{ V}, I_{DS}=2.0\text{ mA}$
Drain-Source Leakage Current	I_{DSS}	-	1.0	mA	$V_{DS}=28.0\text{ V}, V_{GS}=0.0\text{ V}$
Gate-Source Leakage Current	I_{GSS}	-	1.0	μA	$V_{GS}=20.0\text{ V}, V_{DS}=0.0\text{ V}$
Gate Threshold Voltage	$V_{GS(TH)}$	2.0	6.0	V	$V_{DS}=10.0\text{ V}, I_{DS}=10\text{ mA}$
Forward Transconductance	G_M	80	-	mS	$V_{DS}=10.0\text{ V}, I_{DS}=10\text{ mA}, \Delta V_{GS}=1.0\text{ V}, 80\text{ }\mu\text{s Pulse}$
Input Capacitance	C_{ISS}	-	7	pF	$V_{DS}=28.0\text{ V}, F=1.0\text{ MHz}$
Output Capacitance	C_{OSS}	-	5	pF	$V_{DS}=28.0\text{ V}, F=1.0\text{ MHz}$
Reverse Capacitance	C_{RSS}	-	2.4	pF	$V_{DS}=28.0\text{ V}, F=1.0\text{ MHz}$
Power Gain	G_P	11	-	dB	$V_{DD}=28.0\text{ V}, I_{D0}=50\text{ mA}, P_{OUT}=5.0\text{ W}, F=175\text{ MHz}$
Drain Efficiency	η_D	55	-	%	$V_{DD}=28.0\text{ V}, I_{D0}=50\text{ mA}, P_{OUT}=5.0\text{ W}, F=175\text{ MHz}$
Load Mismatch Tolerance	VSWR-T	-	20:1	-	$V_{DD}=28.0\text{ V}, I_{D0}=50\text{ mA}, P_{OUT}=5.0\text{ W}, F=175\text{ MHz}$

Specifications Subject to Change Without Notice.

M/A-COM, Inc.

North America: Tel. (800) 366-2266
Fax (800) 618-8883

■ Asia/Pacific: Tel. +81 (03) 3226-1671
Fax +81 (03) 3226-1451

■ Europe: Tel. +44 (1344) 869 595
Fax +44 (1344) 300 020

Typical Broadband Performance Curves

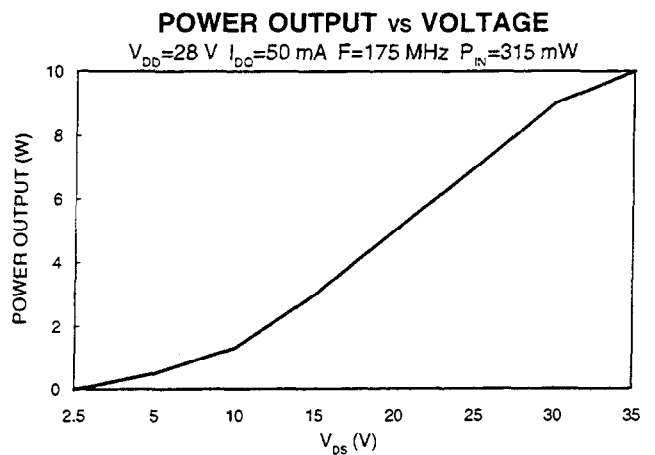
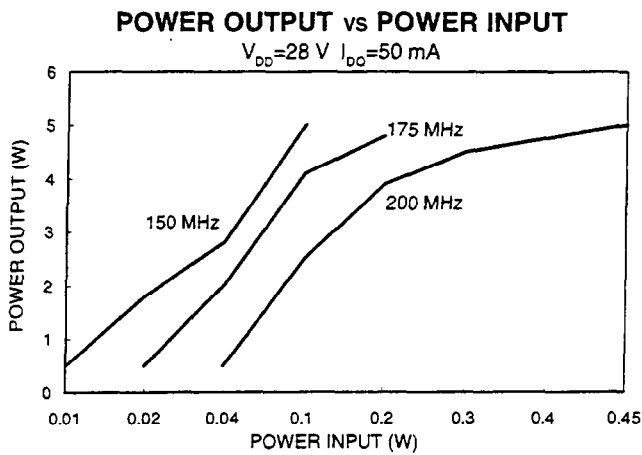
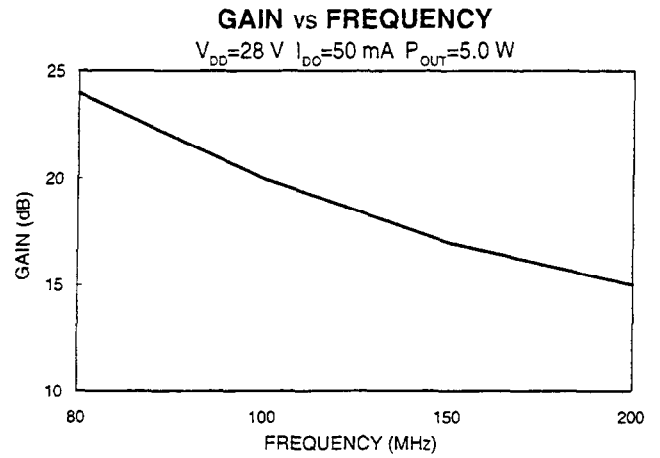
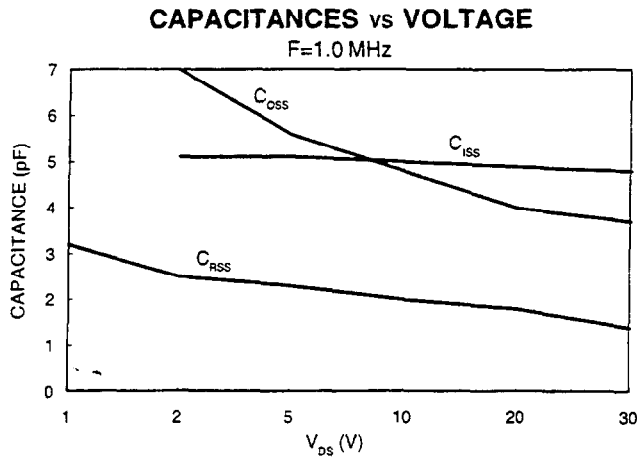

- Continued next page -

Specifications Subject to Change Without Notice.

M/A-COM, Inc.

North America: Tel. (800) 366-2266
 Fax (800) 618-8883

Asia/Pacific: Tel. +81 (03) 3226-1671
 Fax +81 (03) 3226-1451

Europe: Tel. +44 (1344) 869 595
 Fax +44 (1344) 300 020

Typical Device Impedance

Frequency (MHz)	Z _{IN} (OHMS)	Z _{LOAD} (OHMS)
100	15.0 - j 121.0	57.0 + j 23.0
150	39.0 - j 77.0	55.0 + j 23.0
175	41.0 - j 38.0	56.0 + j 19.0
200	34.0 - j 14.0	56.0 + j 20.0

V_{DD}=28 V, I_{DQ}=50 mA, P_{OUT}=5 Watts

Z_{IN} is the series equivalent input impedance of the device from gate to gate.

Z_{LOAD} is the optimum series equivalent load impedance as measured from drain to ground.

RF Test Fixture

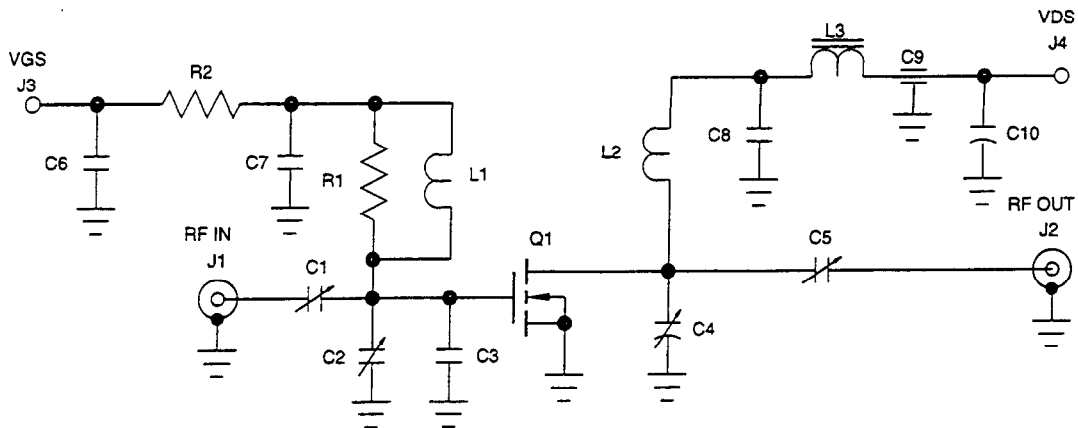

PARTS LIST

C1	TRIMMER CAPACITOR 5-80pF
C2	TRIMMER CAPACITOR 7-100pF
C3	CAPACITOR 15pF
C4,C5	TRIMMER CAPACITOR 9-180pF
C6,C8	CAPACITOR 1000pF
C7	CAPACITOR 500pF
C9	FEEDTHROUGH CAPACITOR 1000pF
C10	ELECTROLYTIC CAPACITOR 25uF 50 VOLTS
L1	2 TURNS OF NO. 12 AWG ON '0.25"
L2	8 TURNS OF NO. 12 AWG ON '0.25"
L3	1 TURN OF NO. 12 AWG W/ SIEMENS DOUBLE
Q1	APERTURE CORE B62152-A0001-X001
BOARD	DU2805S FR4 0.062"

Specifications Subject to Change Without Notice.

M/A-COM, Inc.

North America: Tel. (800) 366-2266
Fax (800) 618-8883

Asia/Pacific: Tel. +81 (03) 3226-1671
Fax +81 (03) 3226-1451

Europe: Tel. +44 (1344) 869 595
Fax +44 (1344) 300 020